

Preparation for first LHC physics with the ALICE Forward Multiplicity Detector

Hans Hjersing Dalsgaard,
Niels Bohr Institute,
University of Copenhagen

Outline

- The Large Hadron Collider
- The ALICE experiment
- The Forward Multiplicity Detector
 - FMD analysis
 - Multiplicity
 - Event plane and flow
- Conclusions

The Large Hadron Collider

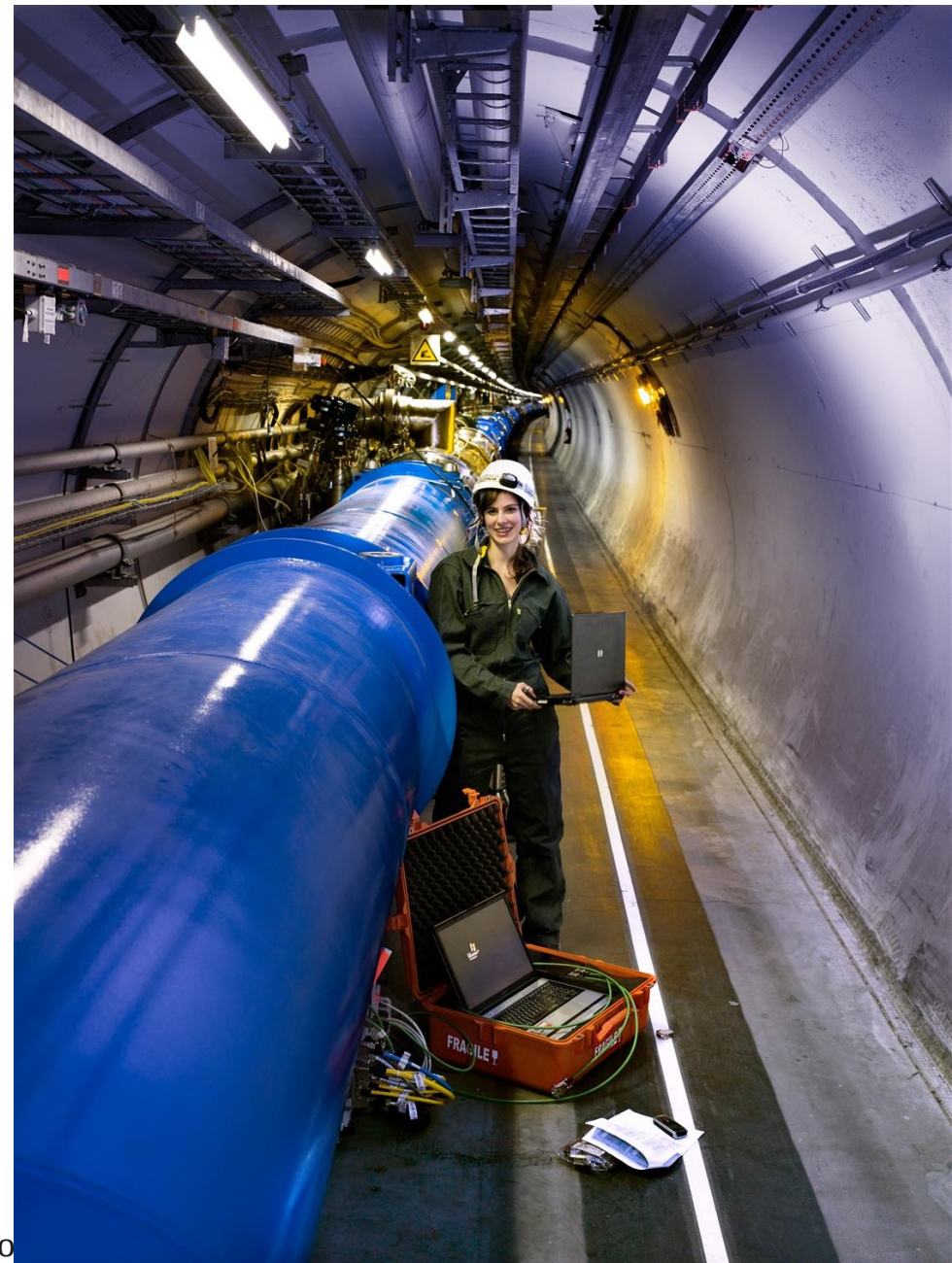
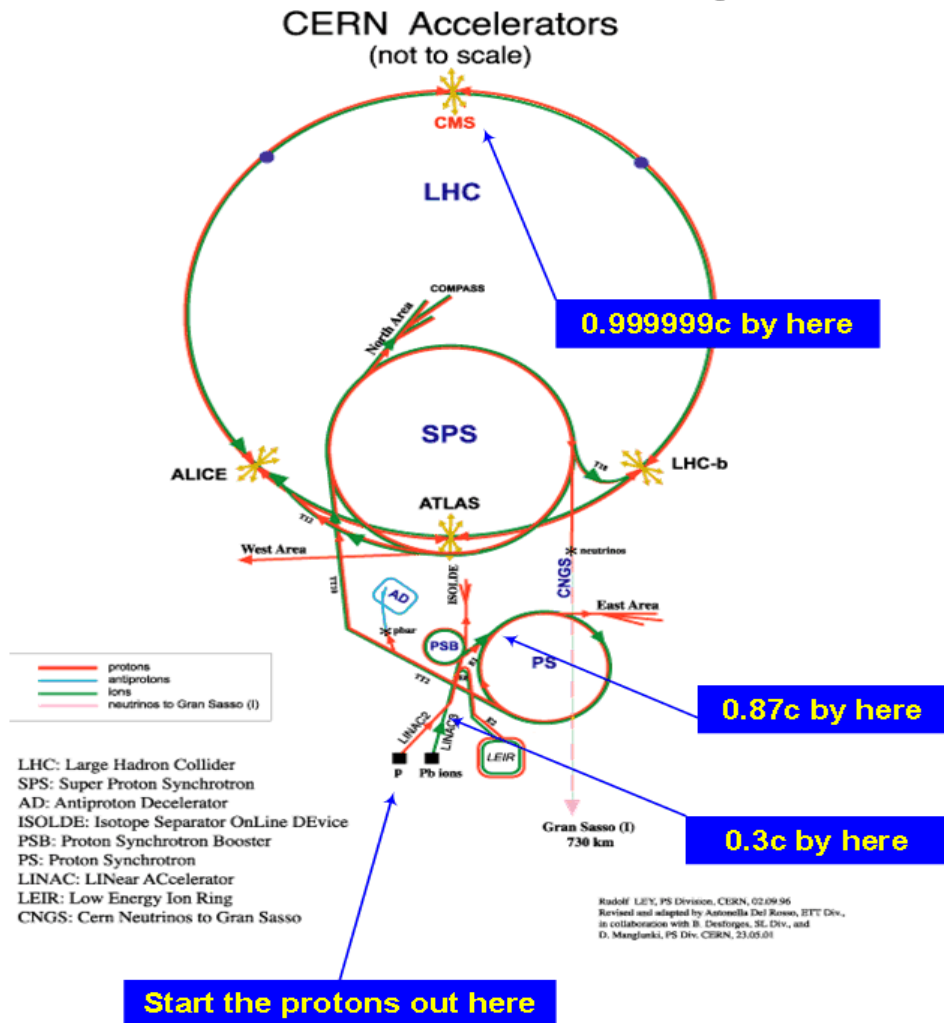

$p+p$ collisions at up to $\sqrt{s} = 14 \text{ TeV}$
 $Pb+Pb$ collisions at up to $\sqrt{s_{NN}} = 5.5 \text{ TeV}$

The ALICE experiment

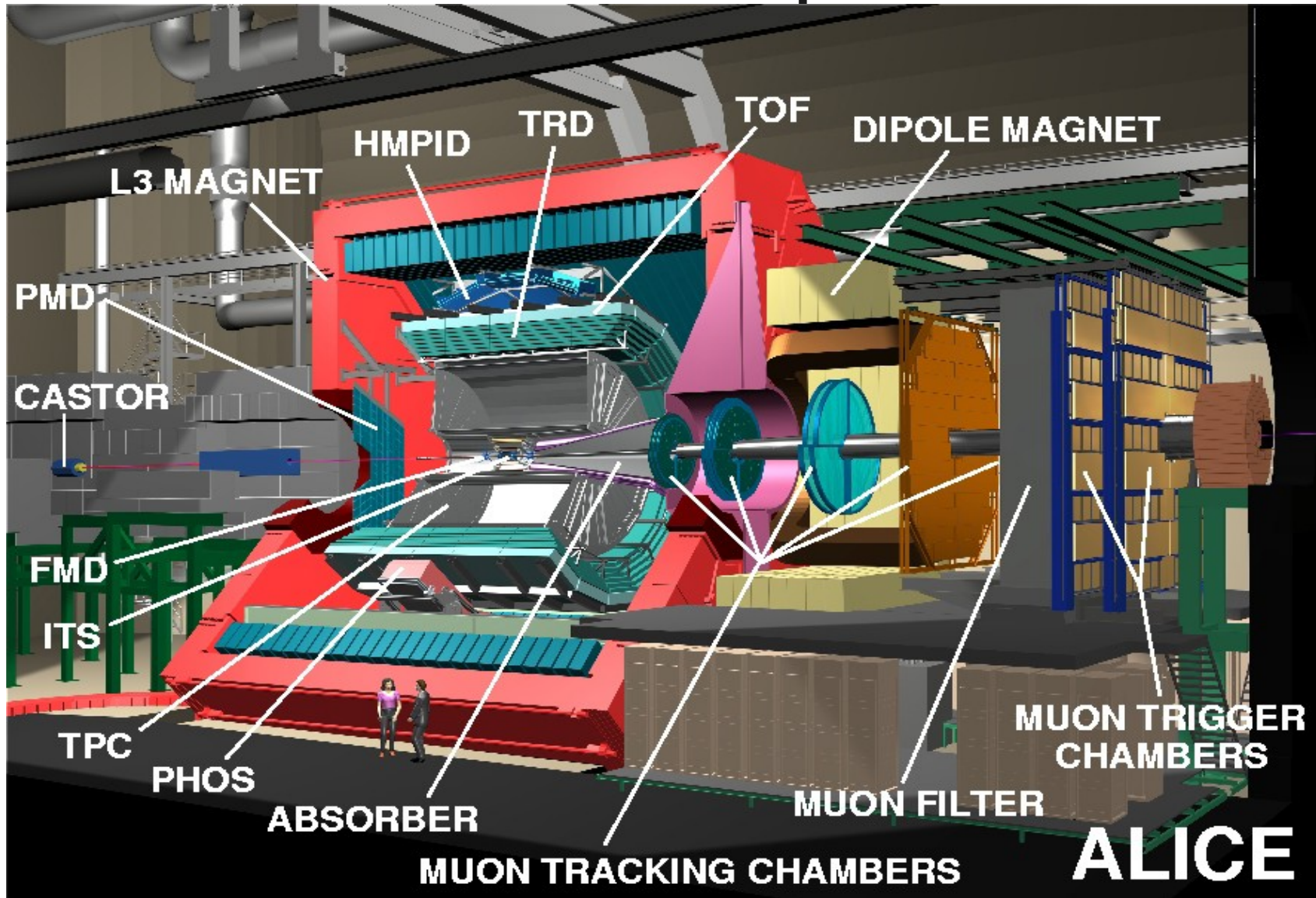

A Large Ion Collider Experiment : ~1000 physicists from ~31 countries

ALICE physics goals

- The primary purpose of ALICE is the study of Pb+Pb collisions and the creation and evolution of a Quark-Gluon Plasma, a state of matter that existed in the early stages of the Universe.
- ALICE will also study p+p collisions, both as a reference for Pb+Pb collisions and to discover new physics.

The Forward Multiplicity Detector

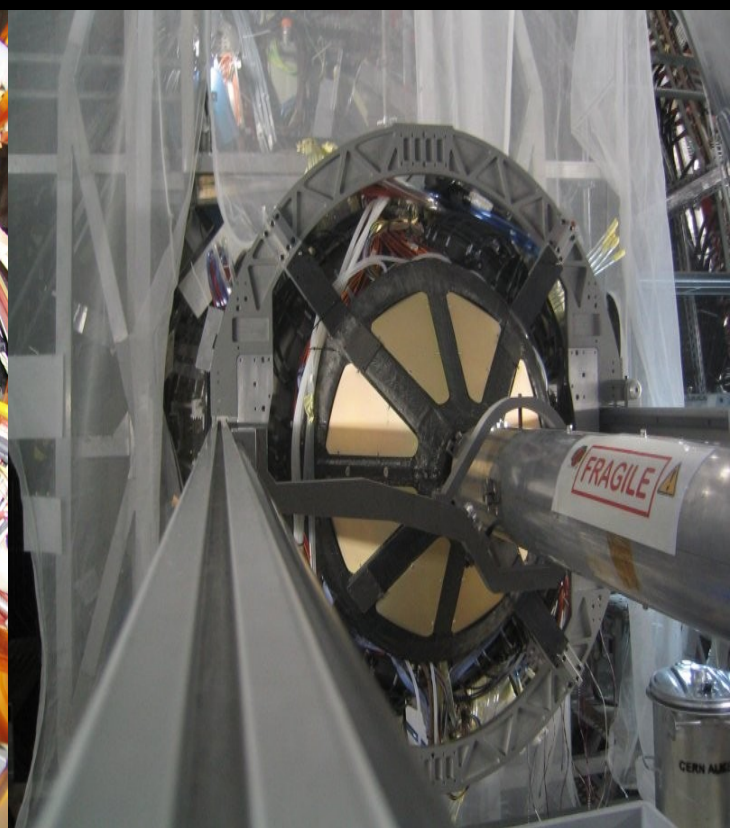
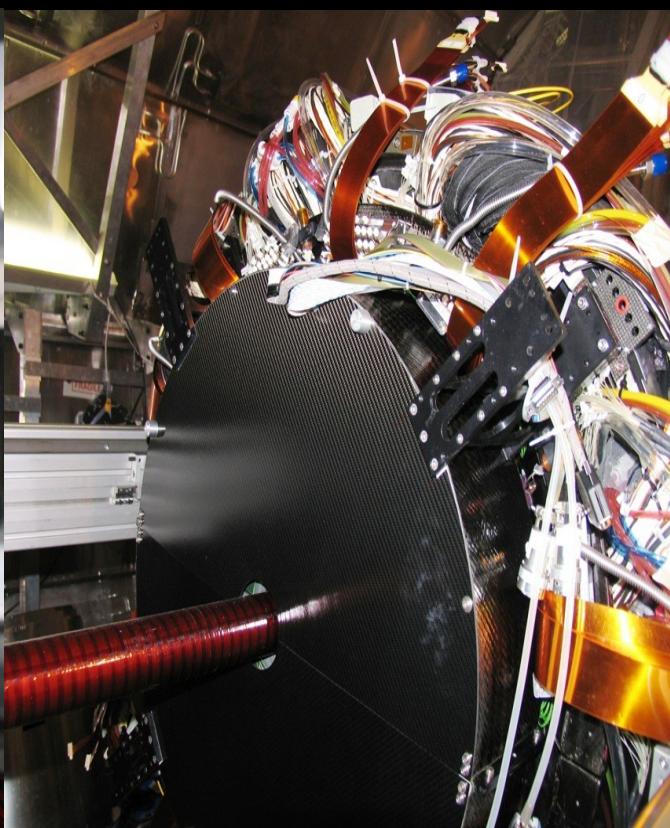
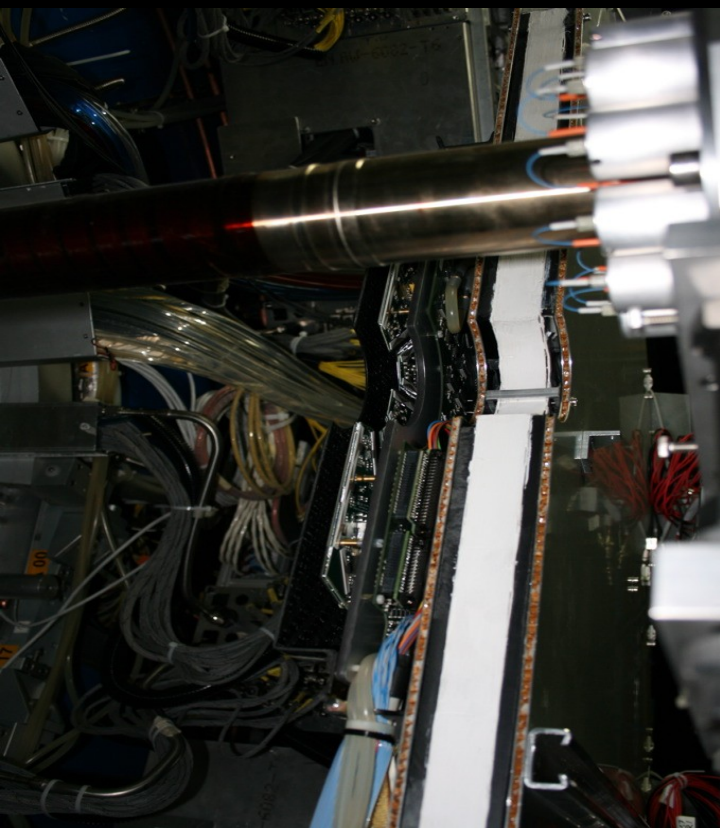
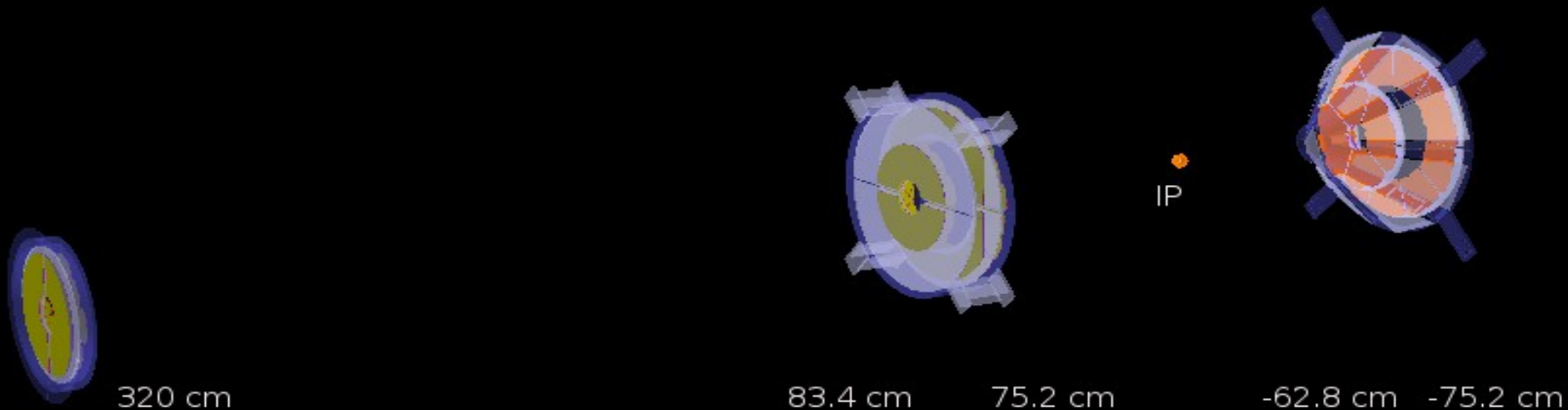

Sketch of the FMD

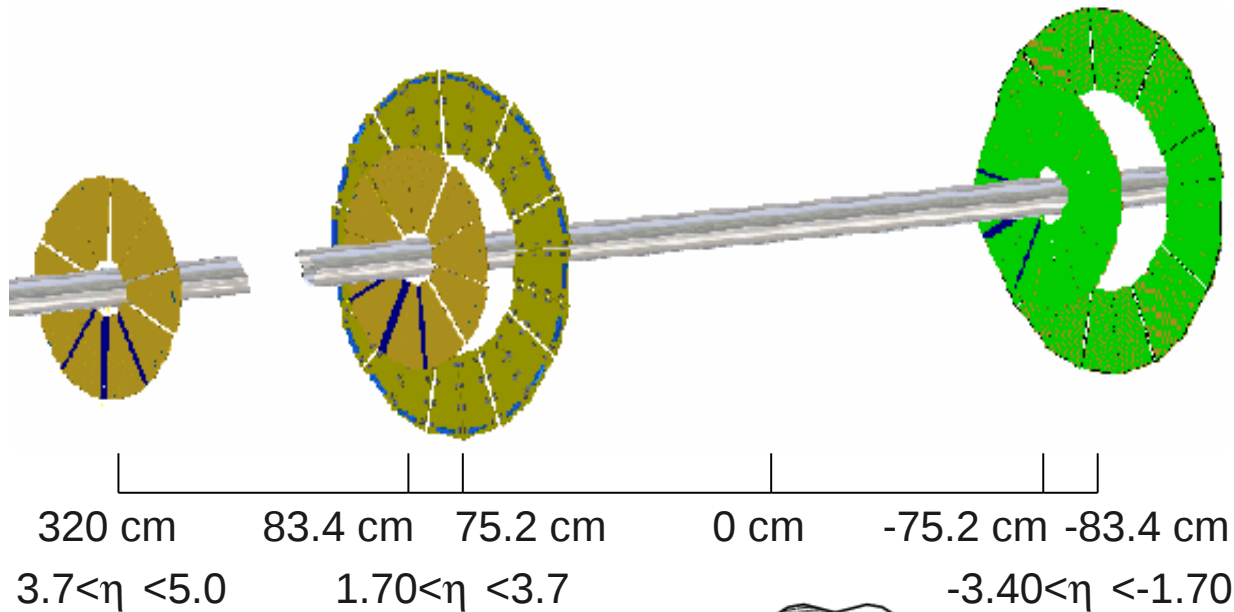

Exploded view of the FMD system. Each ring contains 10240 silicon strips.

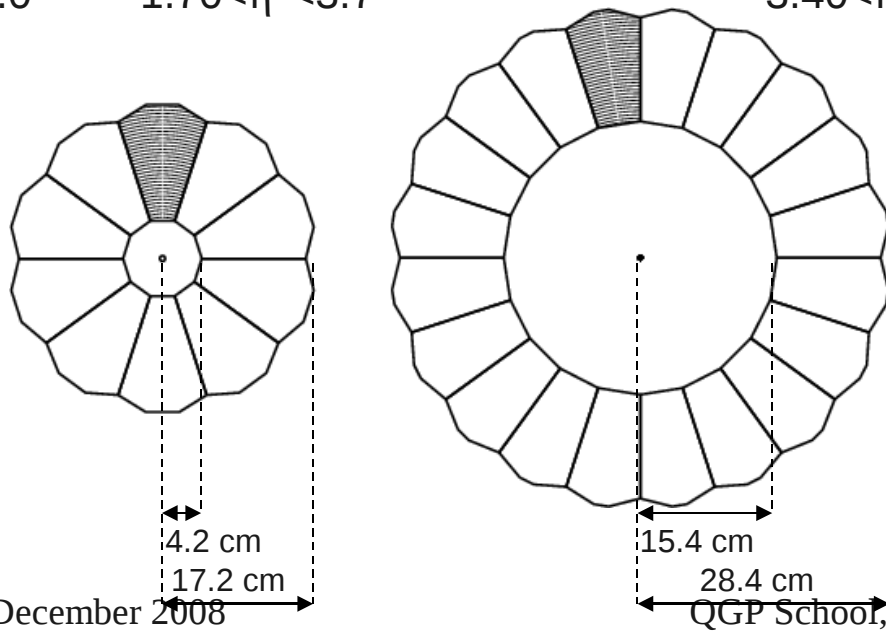

Detailed view of an inner and an outer ring. The inner rings have 512 strips in 20 sectors and the outer rings have 256 strips in 40 sectors.

$dN/d\eta$ coverage

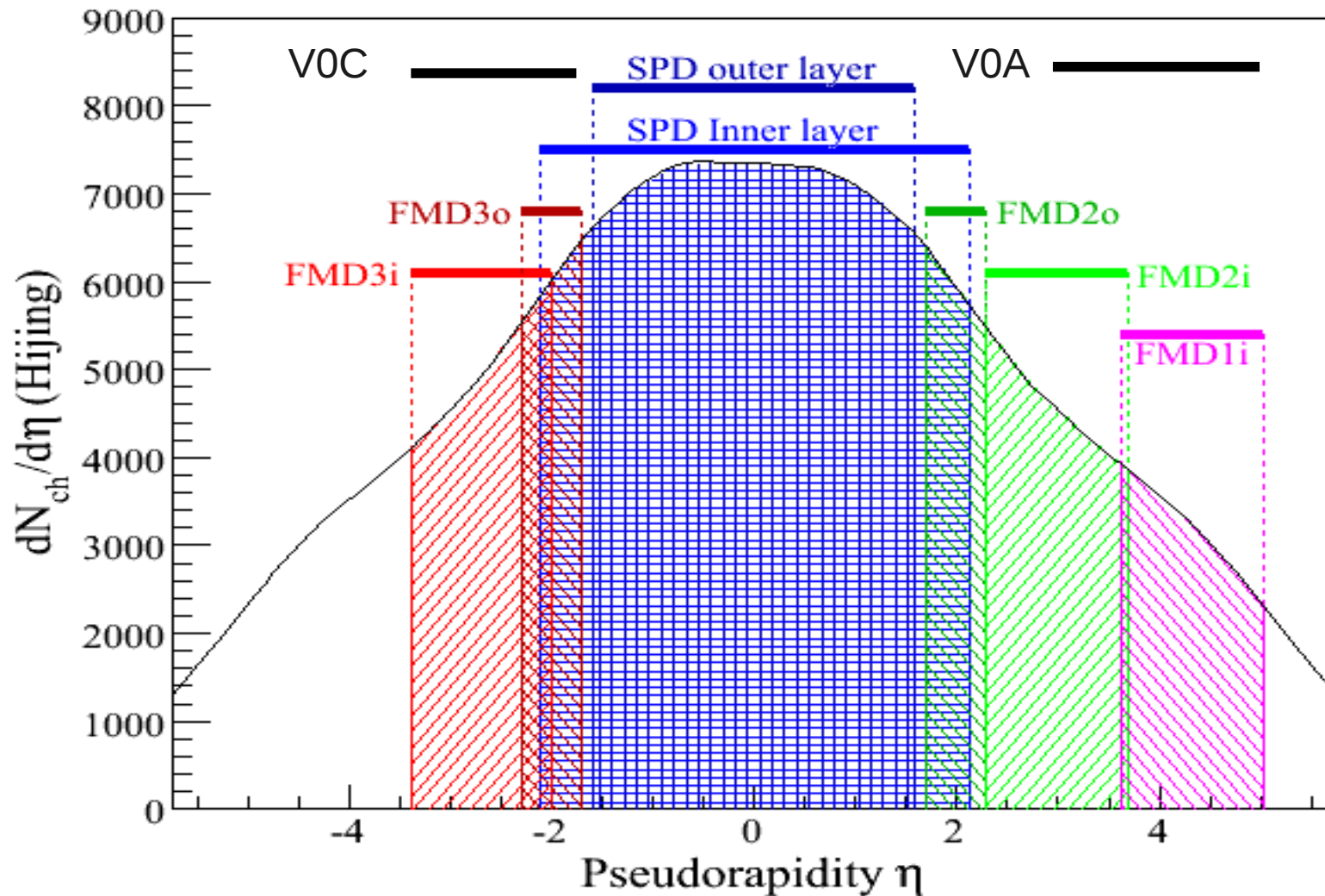

The coverage of the FMD and the SPD and V0 systems.

FMD analysis

- The input of the analysis are the reconstructed energies deposited in the strips.
- To produce physics these signals must be converted into number of particles.
- This requires a correction for hit sharing and a correction for secondary particles from detector interactions and decays.

Energy Distributions

FMD2i

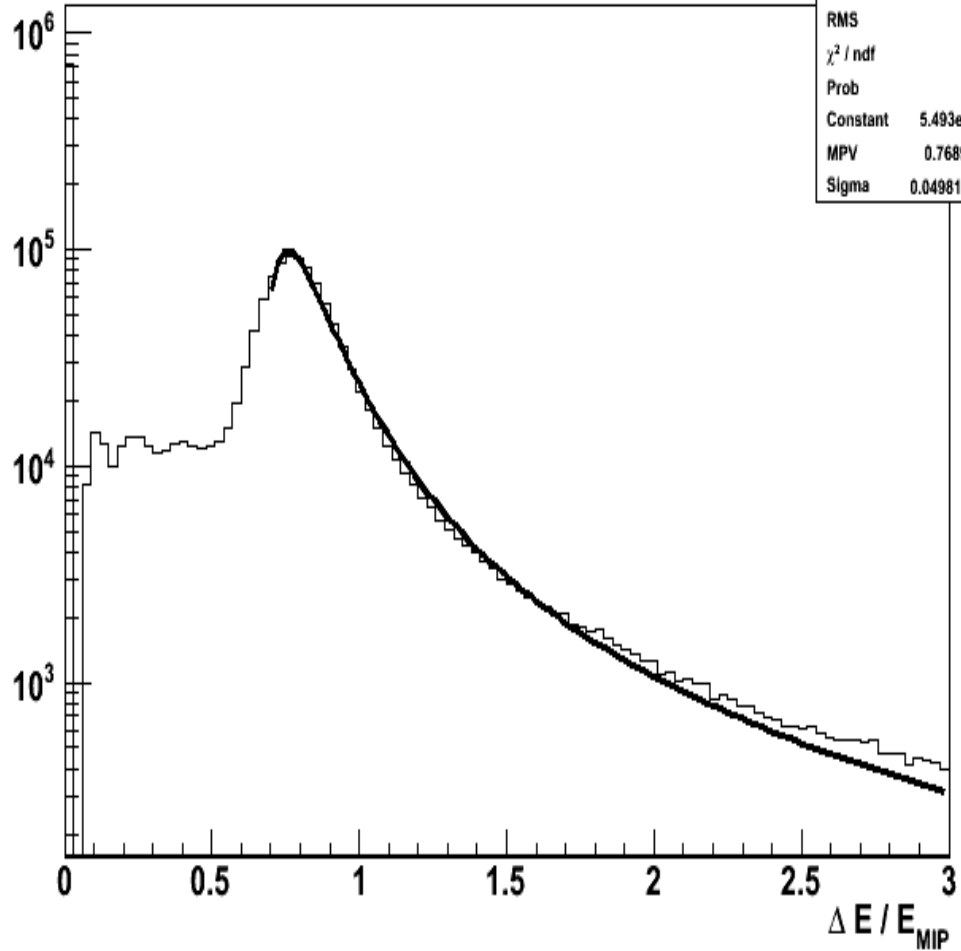

FMD2i

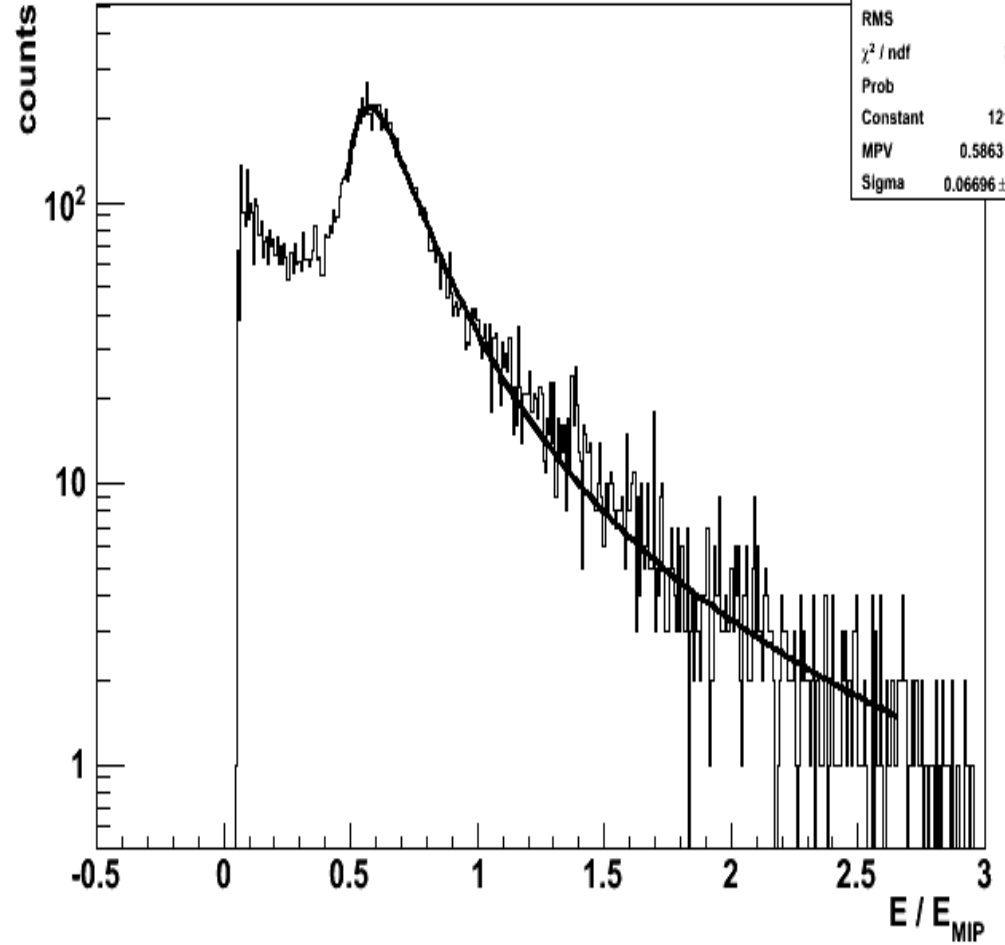

The left plot is the energy distribution of simulated PYTHIA events. The right plot shows beam-gas (or small collimator – beam bursts). The Landau shape is clearly visible in both distributions.

Sharing

Edist before and after sharing in FMD2I

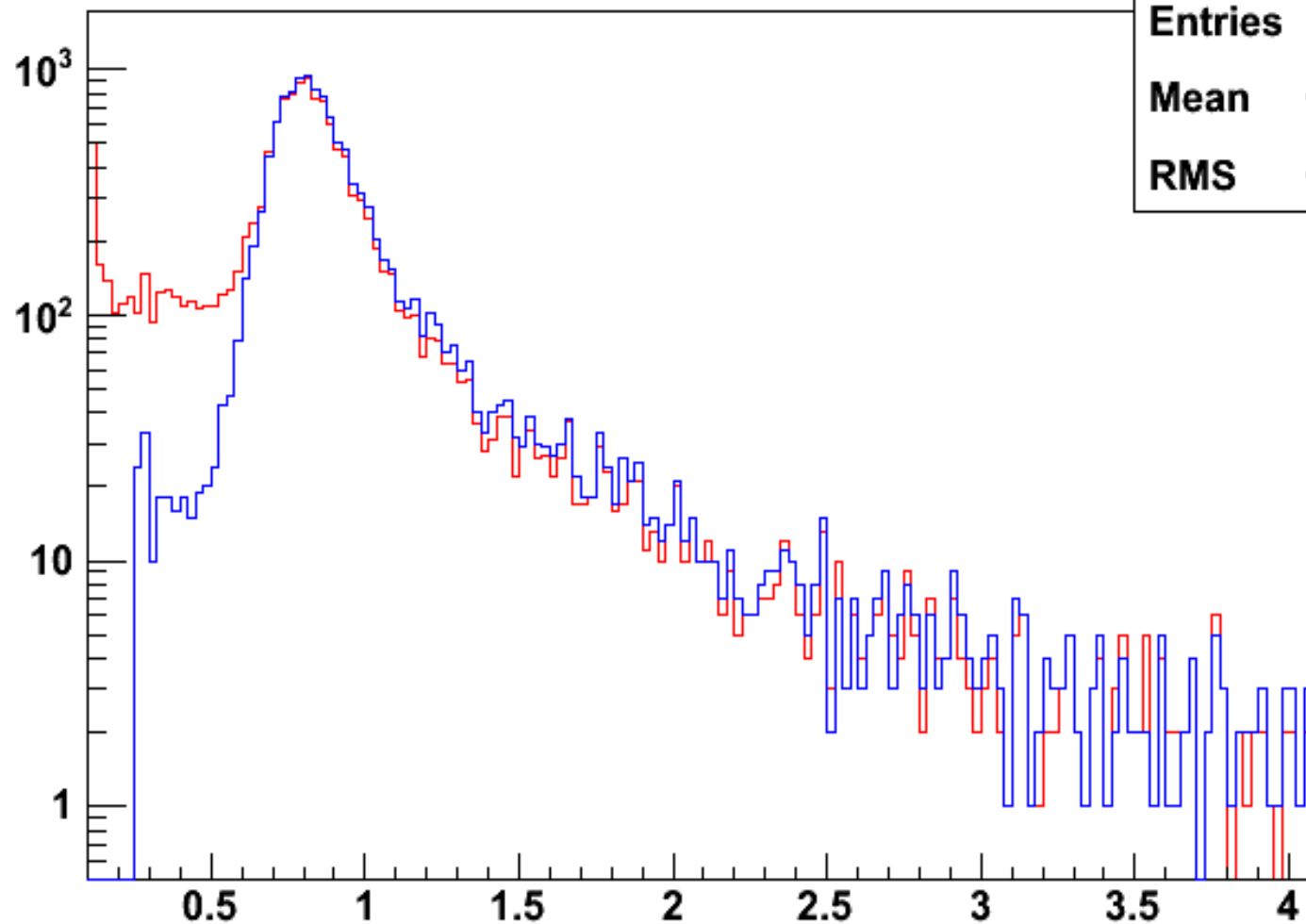

Edist_after_sharing_FMD2I

Entries 12516

Mean 0.9772

RMS 0.5017

The effect of the sharing correction at energy distribution level. The correction takes away most of the shared signals between the Landau peak and zero.

Background

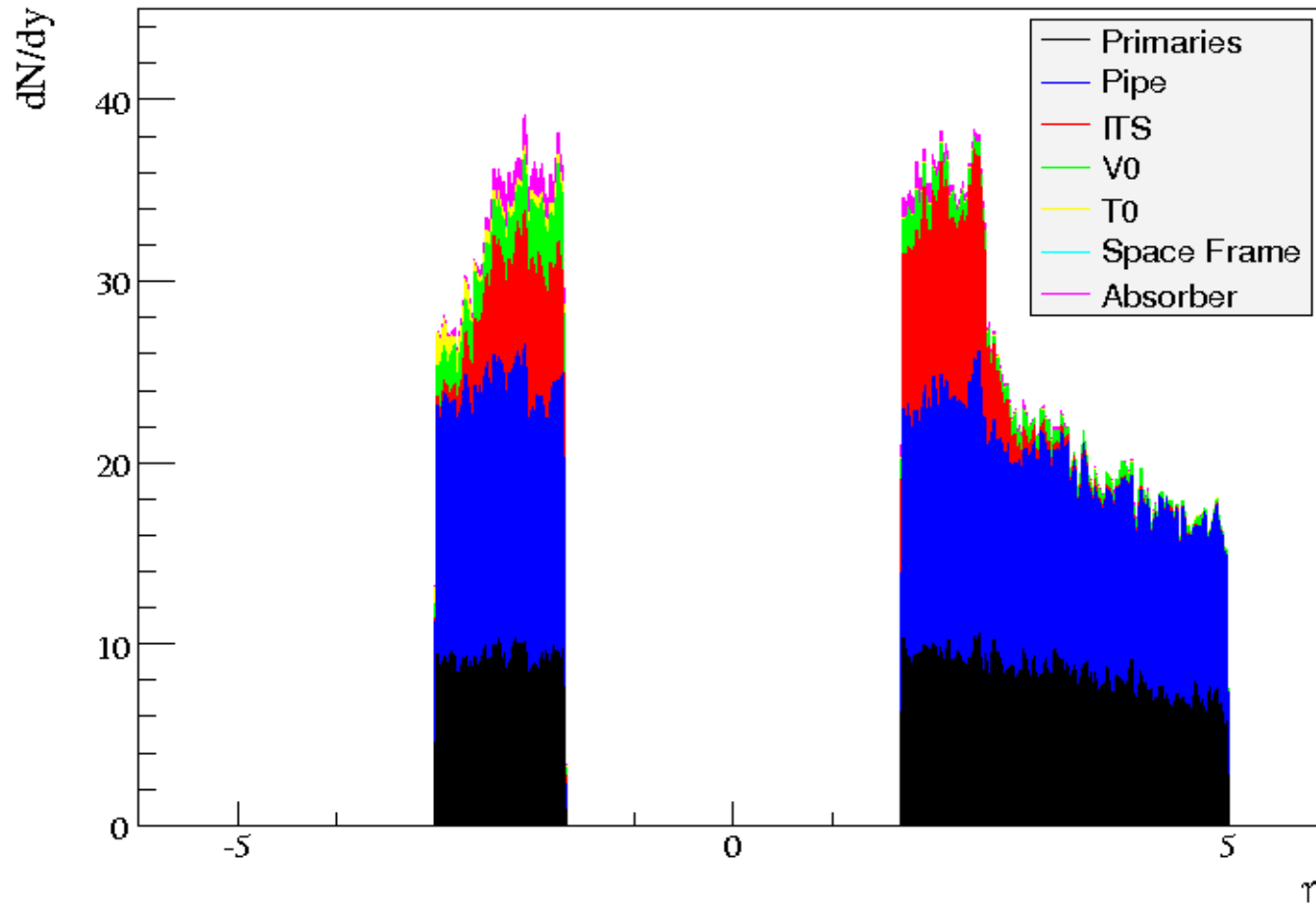

The FMD is hit by a large amount of secondary particles from interactions with detector material and decays. The correction for these effects is crucial in the analysis.

Background Correction

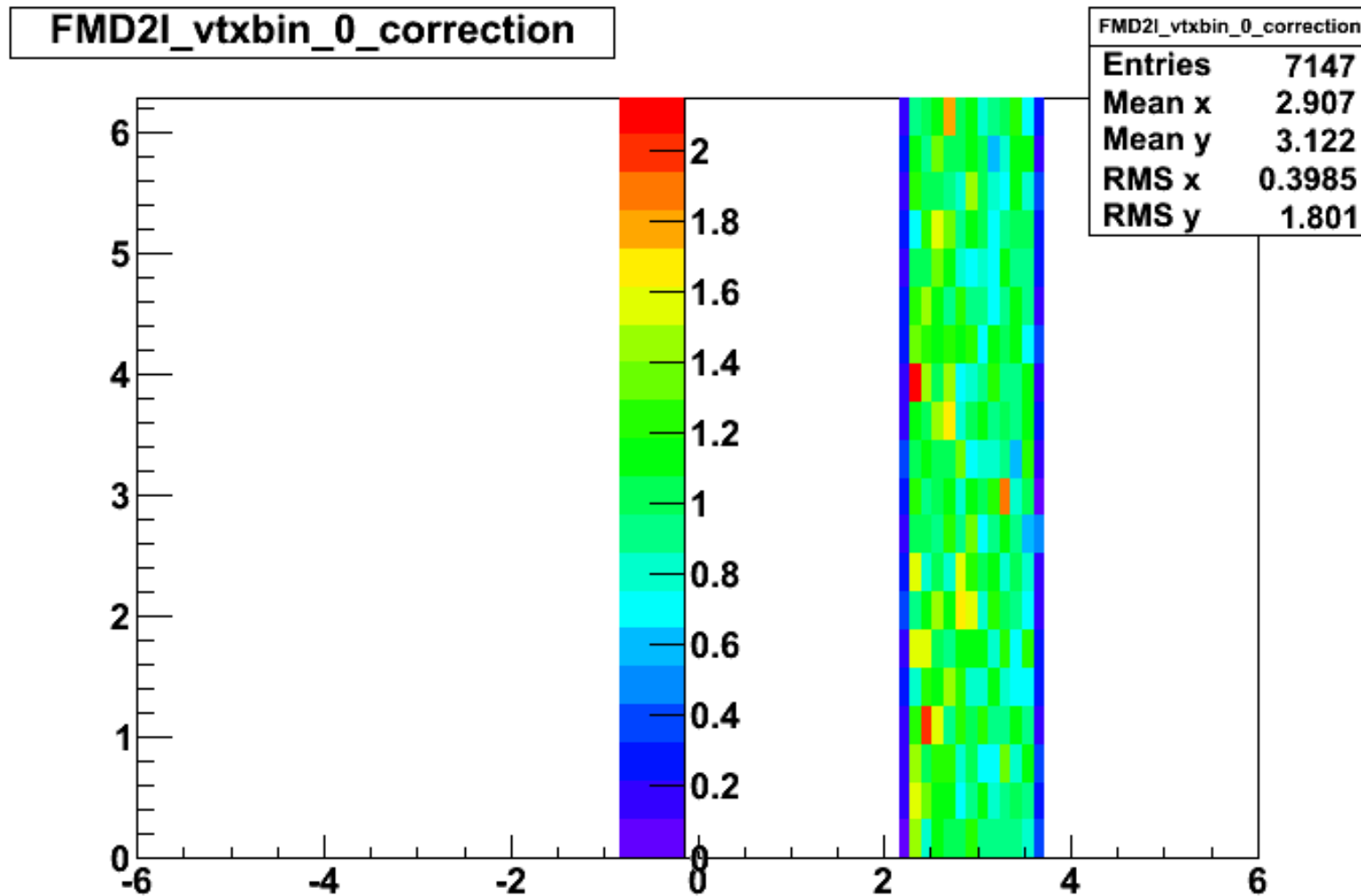

The correction is calculated by division of the histogram of hits with the histogram of primaries. The histograms are in (η, ϕ) bins as the background is not symmetric.

$dN/d\eta$

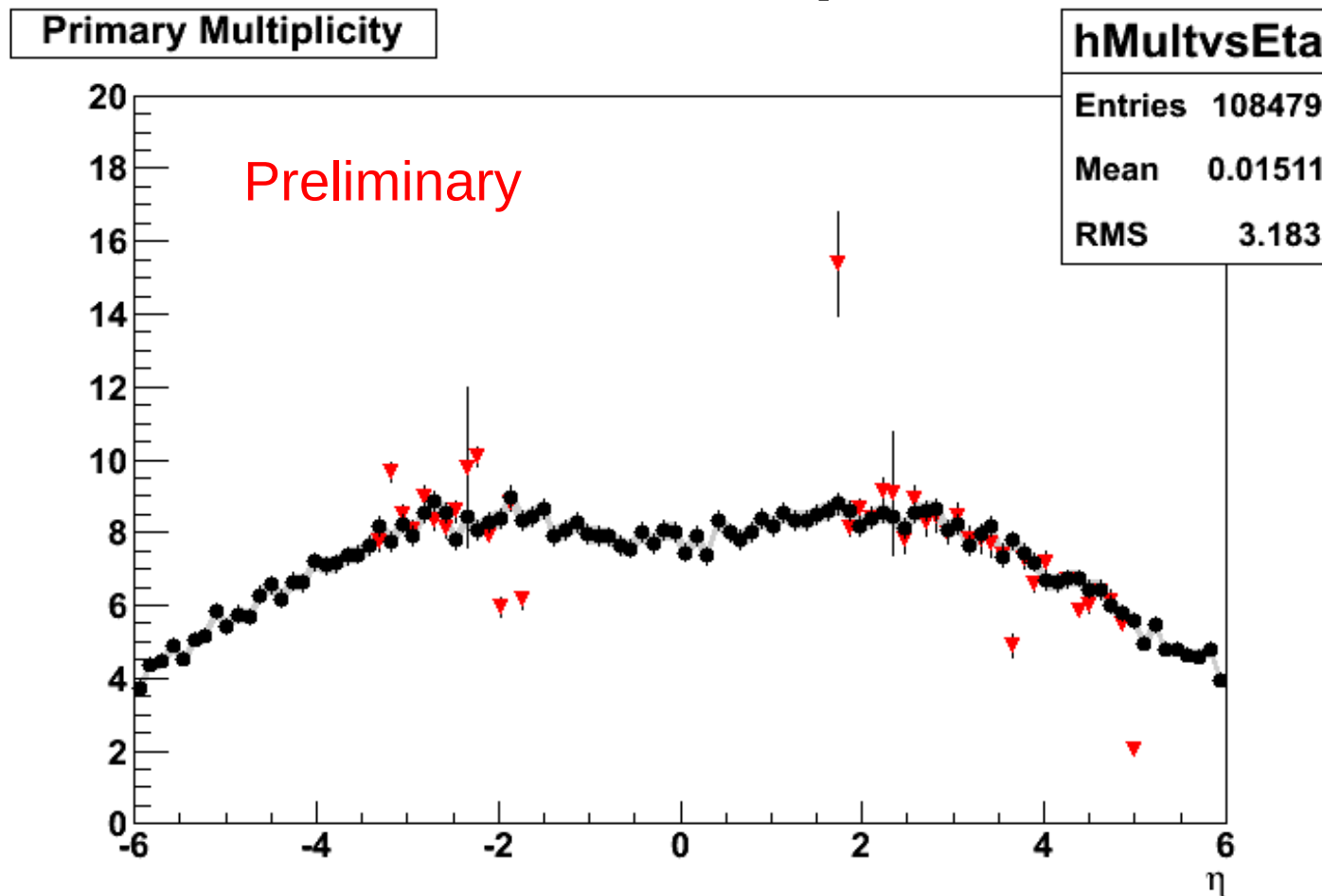

- 1000 pythia events (black points).
- The data have been analysed separately in vertex 'bins' of 2 cm.
- All analysis is carried out in (η, ϕ) histograms since the geometry is not symmetric in ϕ .

Multiplicity

- Apart from $dN/d\eta$ the multiplicity can be used to estimate collision centrality using the total multiplicity.
- Furthermore the forward position of the FMD will enable us to study longitudinal scaling in a window of $\eta' = \eta - y_{\text{beam}}$ of $-7 < \eta' < -3.6$ similar to PHOBOS studies at RHIC.

Event Plane and Flow I

- Due to its 2π azimuthal coverage and good ϕ , the FMD designed to measure the event plane and the flow (v_1 and v_2) of charged particles:

$$E \frac{d^3 N}{d^3 p} = \frac{1}{2\pi} \frac{d^2 N}{p_T dp_T dy} \left(1 + \sum_{n=1}^{\infty} 2v_n \cos(n(\phi - \Psi_r)) \right)$$

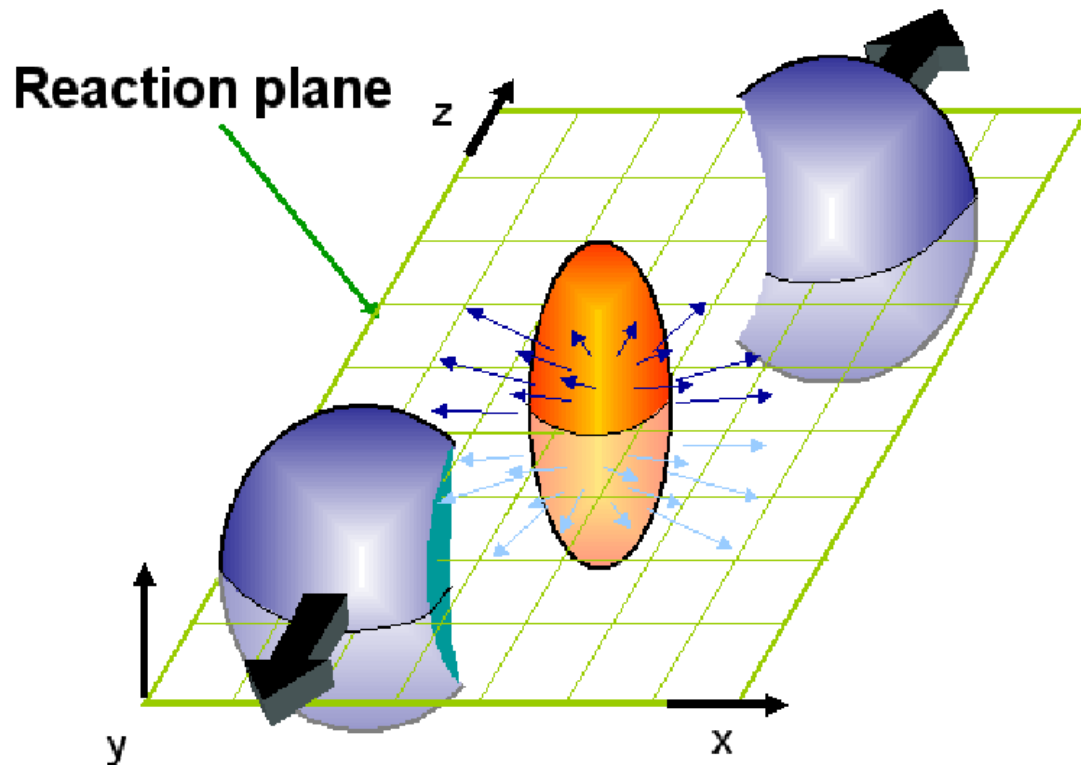

- As the FMD sees a different sample of particles than the ITS and TPC the FMD measurement of the event plane will have no auto-correlations here.

Event Plane and Flow II

- The elliptic flow measurements at RHIC shed new light on the evolution of the collision fireball and in particular its interactions.
- In the most central collisions the fireball was found to be strongly interacting. This labeled the medium discovered at RHIC the 'sQGP'.
- The studies of the flow at LHC will be crucial for the understanding of the medium that will be created in Pb+Pb collisions at LHC.
- Finally the studies of other variables with respect to the event plane will give information about the topology of the collisions.

Results: Event Plane and Flow

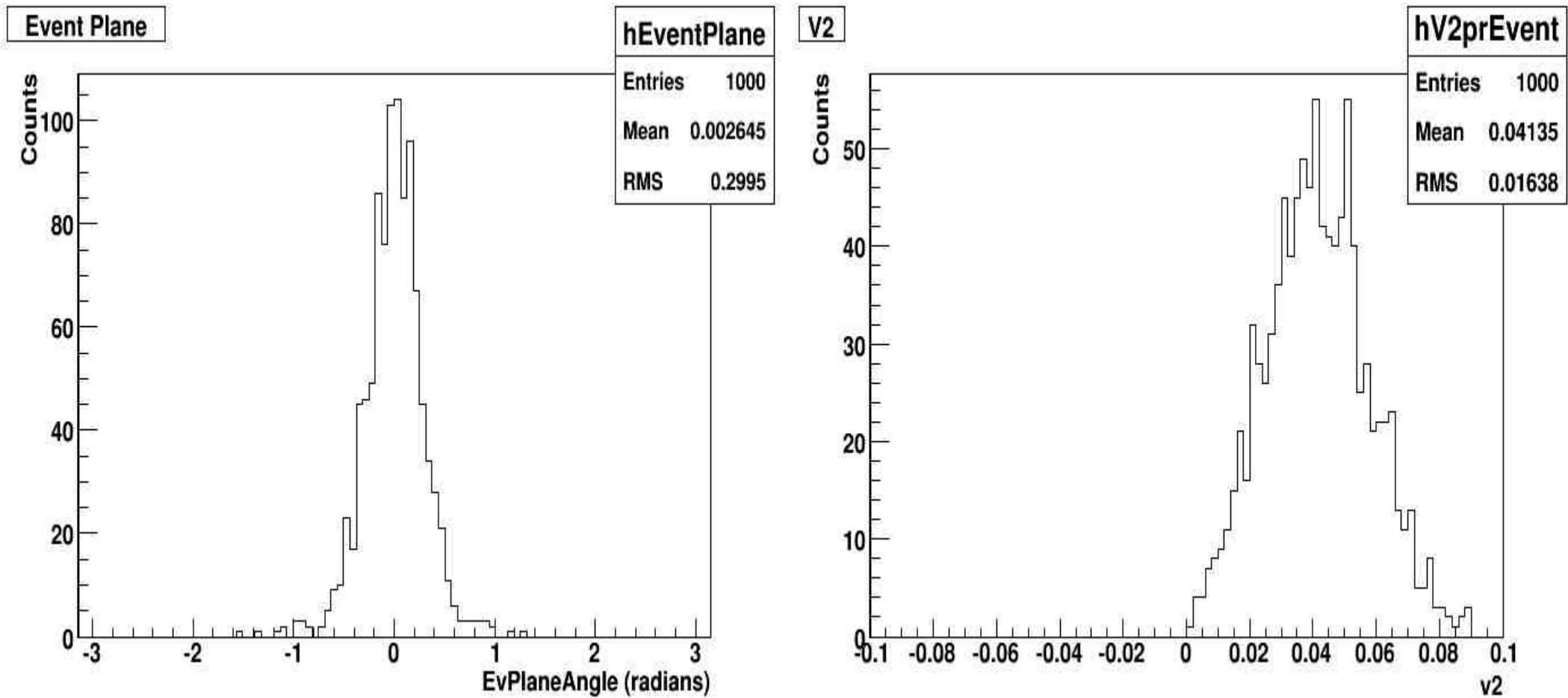

Right plot shows reconstruction of the second order event plane in 1000 PbPb events with the event plane set to zero. Left plot shows reconstruction of v_2 in the same 1000 events in which v_2 was set to 0.05.

Conclusions and outlook

- The FMD will have a fully working and calibrated system for the LHC startup.
- Analysis and studies show that the FMD is able to determine $dN/d\eta$ with a high precision.
- Furthermore the FMD can measure the event plane and the flow with good precision.